



Inventory List

CONTAINER ACCOMMODATION

Our Modules



A1

A ventilated **bare** module with wall lights.



A2

2 fully-furnished **executive** bedrooms in a single module.



A3

A **standard** bedroom module for 4.



B

Separate **toilet** units to ensure hygiene and odour control.



C

Separate **shower** units with full-length shower curtains.



E

An **all-in-one** toilet and shower for convenience and privacy.

Module A1 (Bare)

Container Accommodation



ELECTRICAL

- 2 Wall lights
- 2 Outdoor Lights
- 2 UV Tube Lights
- 2 13A Double Sockets
- 2 Exhaust Fans
- 2 Wall Fans
- 2 Solar Panel Air Conditioners (optional)
- 2 Air Conditioners (optional)
- 2 Outdoor Condensers (optional)

SAFETY & SECURITY

- 2 Home Fire Alarm Devices (HFAD)
- Security Cameras (optional)
- Facial Recognition System (optional)

PROVISIONS

- 32A Single Phase Power Supply



2 MODULES COMBINED

Our modules are also available as combined units.

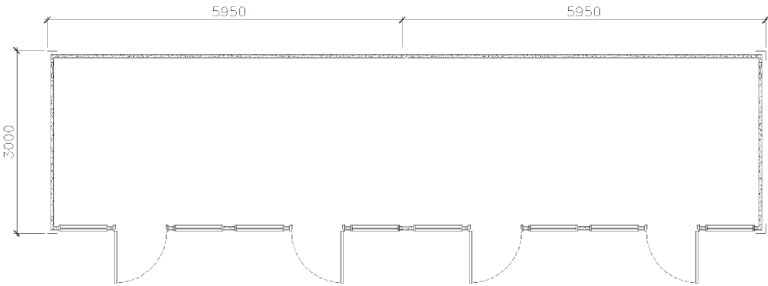

Module A2 (Executive)

Container Accommodation

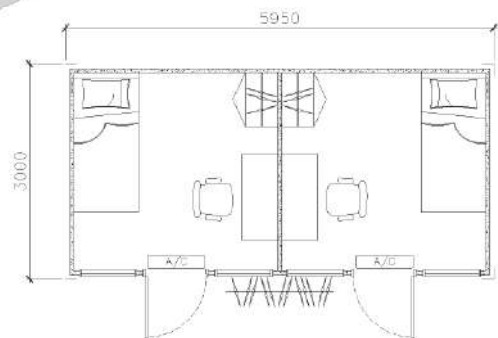

INTERIOR FURNITURE

- 2 Single Bed Frames
- 2 Pillows
- 2 Pillow Covers
- 2 Mattresses
- 2 Bed Sheet Covers
- 2 Wardrobe Cabinets with lock
- 2 Trash Bins
- 2 Study Tables
- 2 Chairs

EXTERIOR FURNITURE

- 2 Outdoor Laundry Racks
- 1 Folding Table

ELECTRICAL

- 4 Wall lights
- 2 Outdoor Lights
- 2 UV Tube Lights
- 4 13A Double Sockets
- 2 Exhaust Fans
- 4 Wall Fans
- 2 Solar Panel Air Conditioners (optional)
- 2 Air Conditioners (optional)
- 2 Outdoor Condensers (optional)

SAFETY & SECURITY

- 2 Home Fire Alarm Devices (HFAD)
- Security Cameras (optional)
- Facial Recognition System (optional)

PROVISIONS

- 32A Single Phase Power Supply



Module A3 (Standard)

Container Accommodation

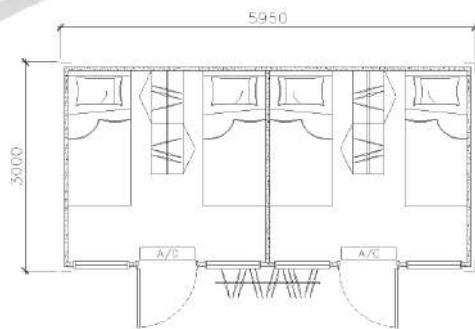

Scan QR code to view tour video

INTERIOR FURNITURE

- 4 Single Bed Frames
- 4 Pillows
- 4 Pillow Covers
- 4 Mattresses
- 4 Bed Sheet Covers
- 4 Wardrobe Cabinets with lock
- 2 Trash Bins
- 4 Side Tables

EXTERIOR FURNITURE

- 2 Outdoor Laundry Racks
- 1 Folding Table
- 4 Folding Chairs

ELECTRICAL

- 4 Wall lights
- 2 Outdoor Lights
- 2 UV Tube Lights
- 4 13A Double Sockets
- 2 Exhaust Fans
- 4 Wall Fans
- 2 Solar Panel Air Conditioners (optional)
- 2 Air Conditioners (optional)
- 2 Outdoor Condensers (optional)

SAFETY & SECURITY

- 2 Home Fire Alarm Devices (HFAD)
- Security Cameras (optional)
- Facial Recognition System (optional)

PROVISIONS

- 32A Single Phase Power Supply

Module B (Toilet)

Container Accommodation

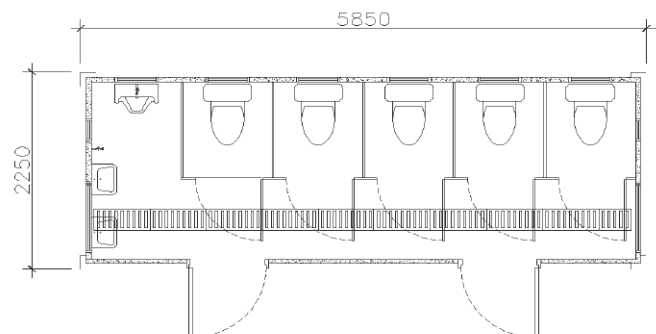
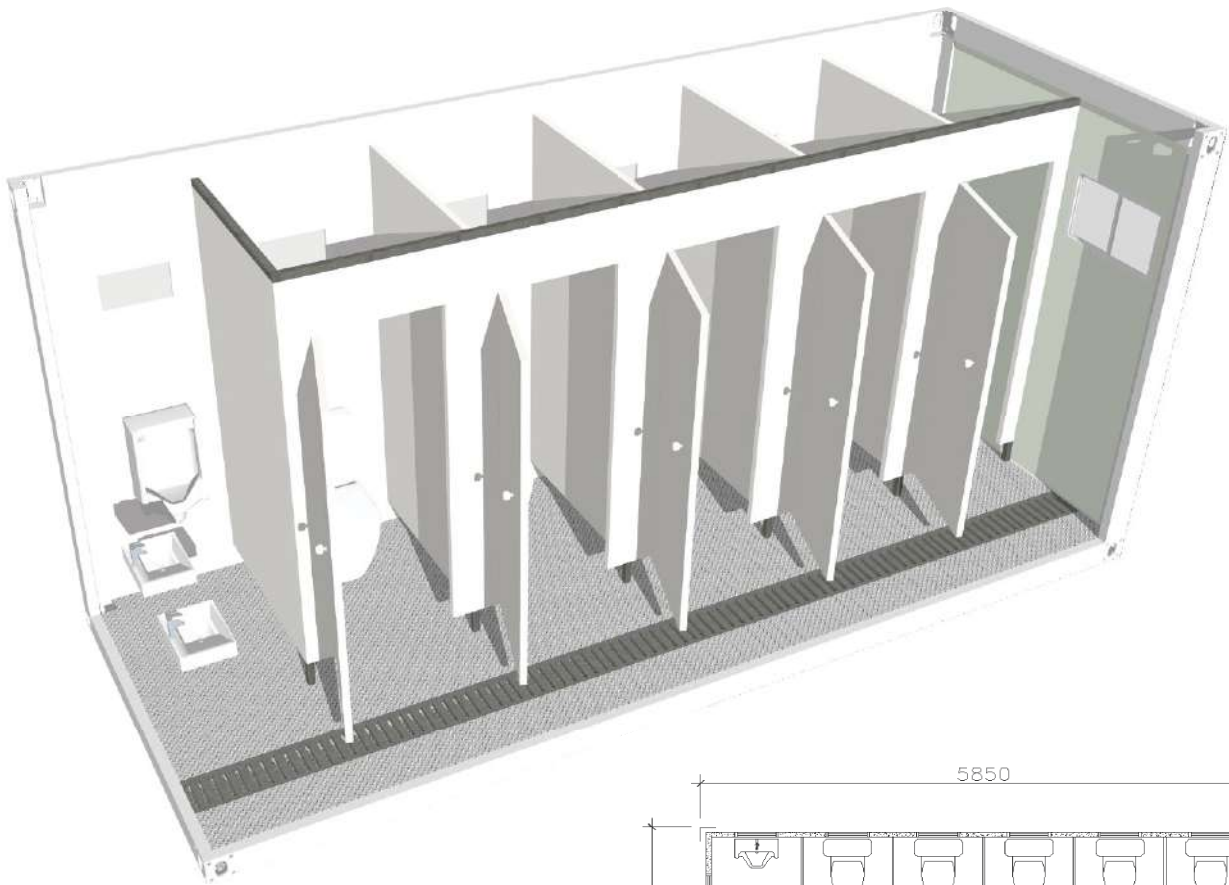

FITTINGS

- 5 Water Closets
- 1 Urinal
- 2 Sinks
- 3 Taps

LIGHTING

- 3 Ceiling Lights
- 1 Outdoor Light
- 1 Distribution Board

PROVISIONS

- 32A Single Phase Power Supply
- Water Inlet & Outlet
- Water Discharge
- Sewage Discharge

Module C (Shower)

Container Accommodation

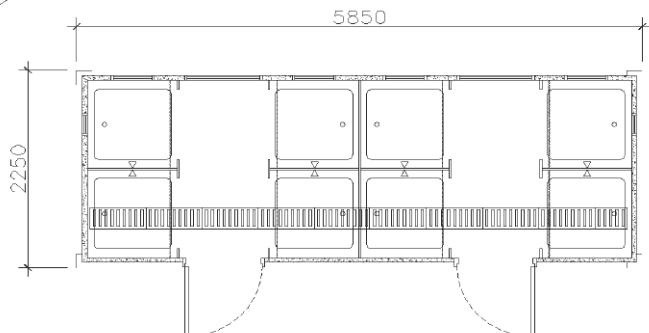
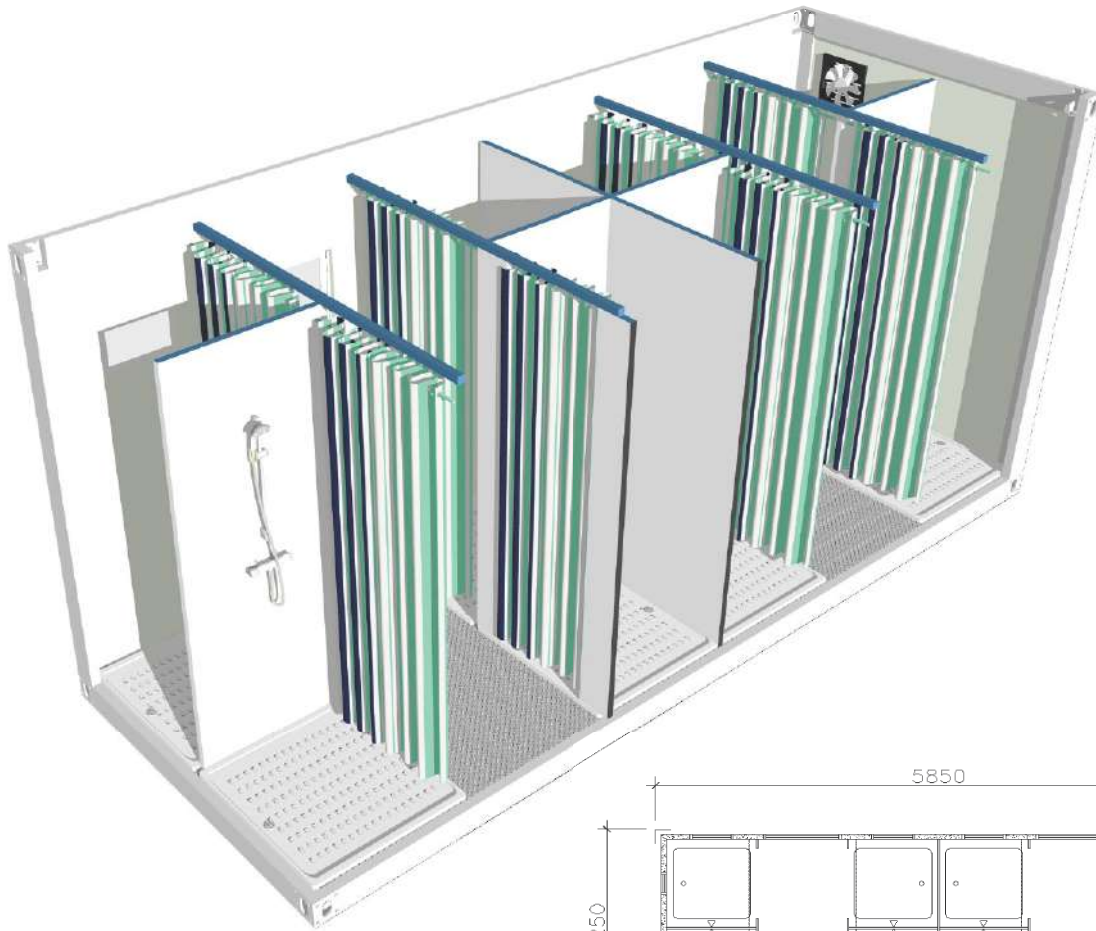

FITTINGS

- 8 Shower Trays
- 8 Instant Heaters with Shower (optional)
- 8 Shower Curtains with Pole

ELECTRICAL

- 4 Ceiling Lights
- 1 Outdoor Light
- 2 Exhaust Fans
- 1 Distribution Board

PROVISIONS

- 32A Single Phase Power Supply
- Water Inlet & Outlet
- Water Discharge
- Sewage Discharge

Module E (All-in-One)

Container Accommodation

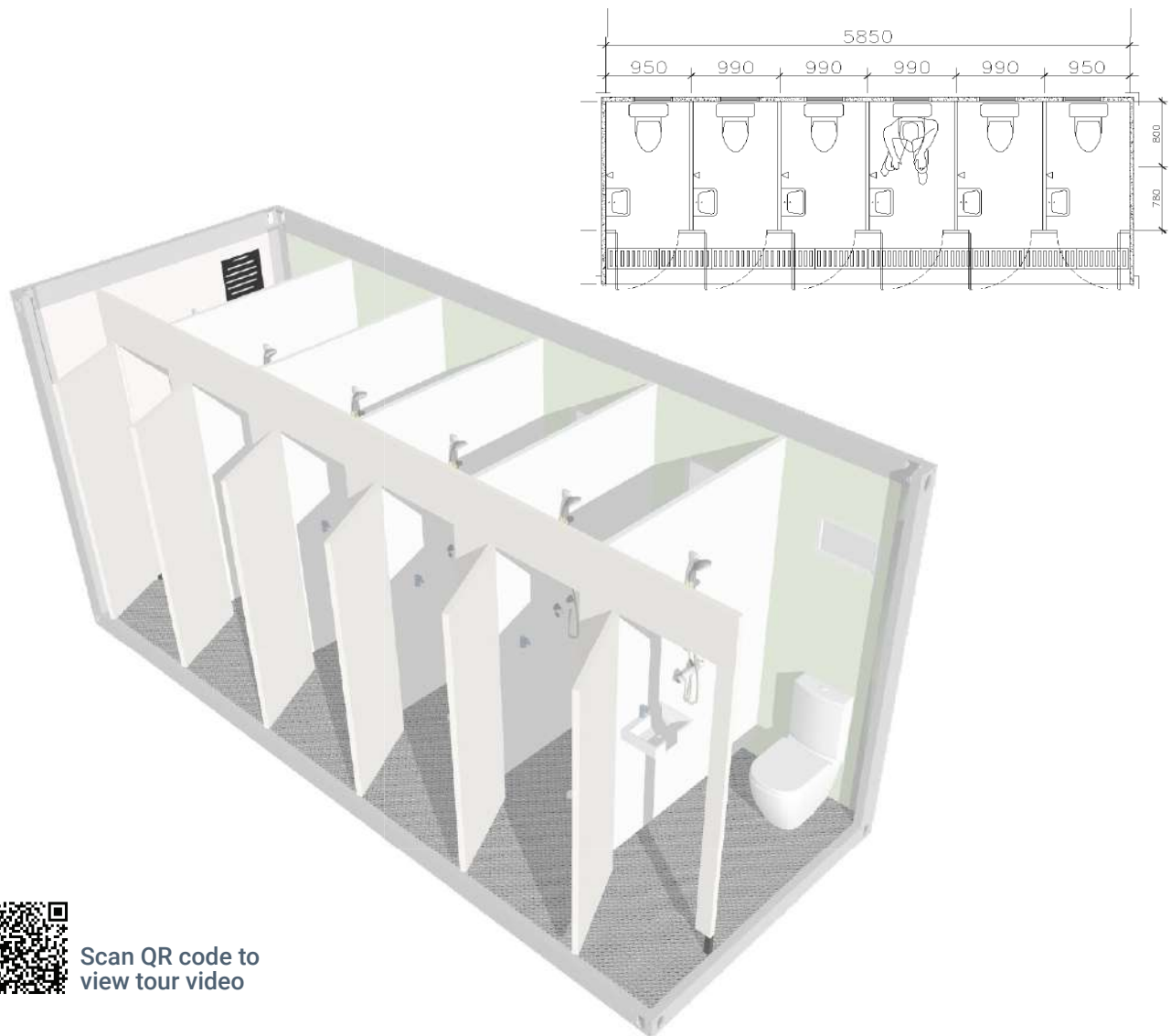

Scan QR code to view tour video

FITTINGS

- 6 Water Closets
- 6 Instant Heaters with Shower (optional)
- 6 Sinks
- 6 Taps
- 6 WC Bidets

ELECTRICAL

- 6 Ceiling Lights
- 1 Outdoor Light
- 2 Exhaust Fans
- 1 Distribution Board

PROVISIONS

- 32A Single Phase Power Supply
- Water Inlet & Outlet
- Water Discharge
- Sewage Discharge

Module F (All-in-One Single)

Container Accommodation

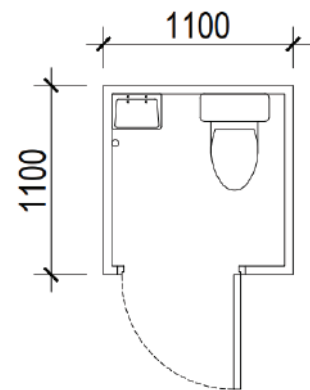

Scan QR code to view tour video

FITTINGS

- 1 Water Closet
- 1 Shower head & holder
- 1 Sink
- 1 Tap

ELECTRICAL

- 1 Wall light
- 1 Exhaust Fan

PROVISIONS

- 32A Single Phase Power Supply
- Water Inlet & Outlet
- Water Discharge
- Sewage Discharge

Sale: \$1200/module
Rent: \$240/month

Application Process

You may also opt for Greyline to file all the required applications for you



Are our Container Accommodation Units suitable for your needs?

Before proceeding with the application process, you may book a consultation with us to determine the feasibility of your proposed system. Check the contact page for details.

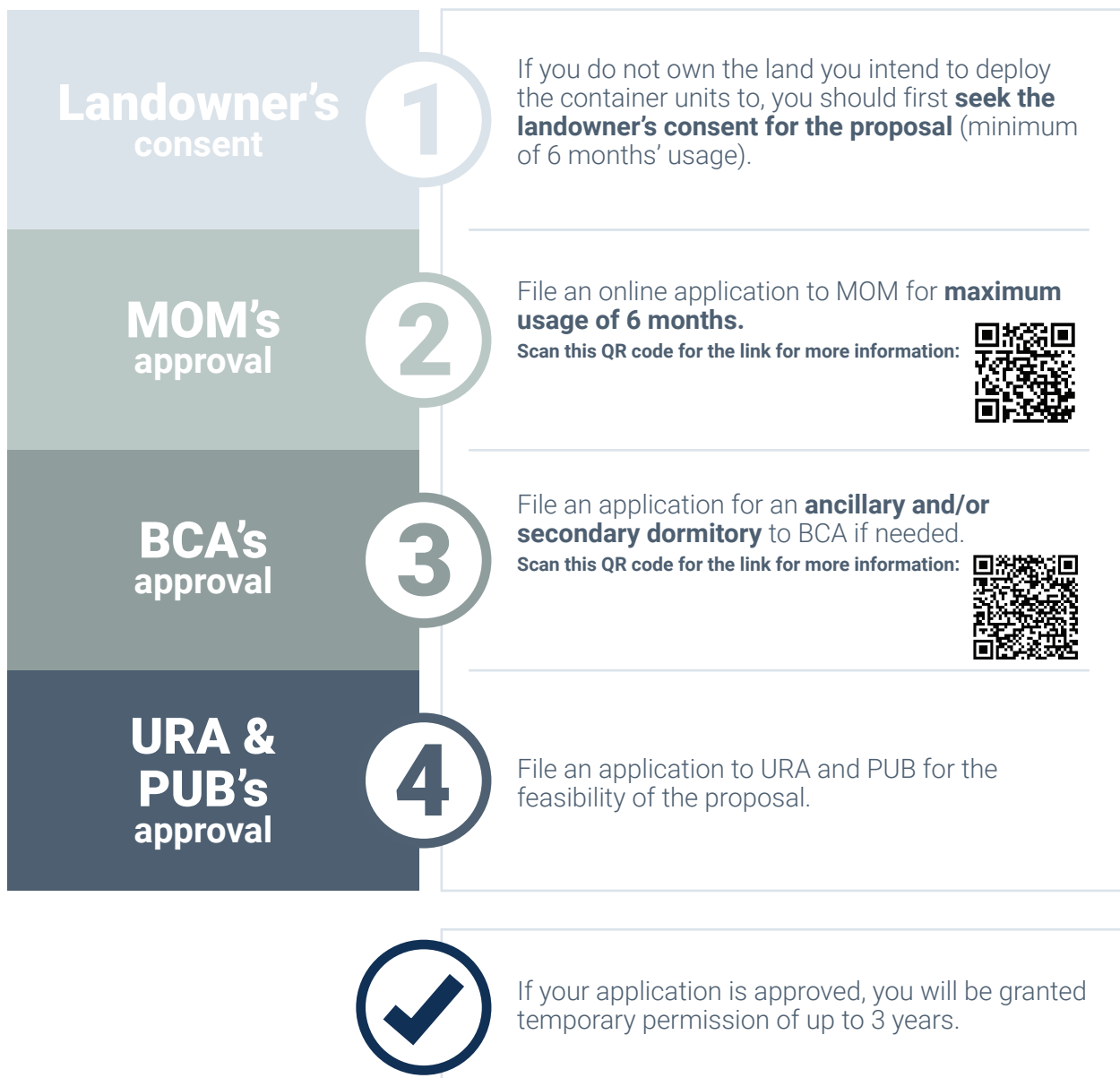



We look forward to
working with you.

Contact

Sales, enquiries and consultations

Phone: +65 6272 1711

Mobile: +65 8892 7811

enquiry@greylinesolution.com.sg

<http://greylinesolution.com.sg/>

1 Tampines North Drive 1, #08-22 T-Space Singapore 528559



Scan QR code to
drop us an enquiry

After Sales Maintenance

support@greylinesolution.com.sg



Scan QR code for
maintenance enquiry form

Social Media



facebook.com/greylinesolutionpteltd
[@greylinesolutionpteltd](https://www.instagram.com/greylinesolutionpteltd) (instagram)
[linkedin.com/company/greylinesolution-pte-ltd/](https://www.linkedin.com/company/greylinesolution-pte-ltd/)
shorturl.at/wHW39 (youtube)
+65 8892 7811 (whatsapp)

